

dbx

Models 163 and 164

Instruction Manual

WARNING

**TO PREVENT FIRE OR SHOCK HAZARD,
DO NOT EXPOSE THIS COMPONENT
TO RAIN OR MOISTURE.**

This triangle, which appears on your component, alerts you to the presence of uninsulated dangerous voltage inside the enclosure -- voltage that may be sufficient to constitute a risk of shock.



This triangle also appears on your component, and it alerts you to important operating and maintenance instructions in the accompanying literature.

CAUTION
To Further Reduce the Risk of Shock, Do Not Remove the Cover or Back. There Are No User-Serviceable Parts Inside; Refer All Servicing to Qualified Personnel.

INSPECTION AND INSTALLATION

Your unit was carefully packed at the factory in a carton designed to protect it. Nevertheless, we recommend examining both carton and contents for any signs of damage that may have occurred during shipping. If there is evidence of damage, don't destroy the carton or any of the packing material, and notify your dbx dealer immediately.

In any case it is a good idea to save the carton and packing materials should you ever need to ship your unit in the future.

In addition to a unit and this instruction manual, the carton should contain hookup cables with RCA phono (pin) plugs and a warranty/registration card.

"dbx" and "Over Easy" are registered trademarks of dbx Inc., Newton, Mass., USA

CONTENTS

Introduction	1
More on features and performance	3
Applications	4
Mono or stereo?	5
Other dbx compressor/limiters	5
The compressor as tool	6
Performance curves	facing page 6
Brief operating instructions	7
Installation	8
Signal connections	9
Input & output impedances and terminations	9-10
Operation	10
Compressor/limiters: a review	12
More applications	13
Specifications	17
Schematics	19-20
Warranty and factory service	21
Important information for users in the UK	22

INTRODUCTION

The dbx Model 163 and 164 compressor/limiter feature dbx's Over Easy compression. Over Easy refers to a "soft-knee" compression characteristic that provides virtually inaudible gain control at ratios up to infinite compression. Other unique dbx circuit designs such as true-rms-level detection, feedforward gain reduction, and automatically variable attack and release times provide the 163 with audibly superior performance.

The Model 164 is a stereo-tracking version of the 163, working with a pair of channels as opposed to the single (mono) channel of the 163. In all other respects the 163 and 164 are identical, and throughout this manual we make reference only to the 163, for the sake of convenience. The 164 accomplishes its stereo tracking by feeding the signal in each channel to a special stereo rms detector, which computes the true-rms sum of the two channel levels. This signal is then fed forward to activate the gain-change circuitry for both channels, ensuring an accurate and constant image.

Anyone who has ever tried to fine-tune a studio-type compressor/limiter will appreciate the Model 163's ease of operation. A single front-panel COMPRESSION knob simultaneously adjusts the threshold of compression and the overall system gain, thereby maintaining essentially constant output level. Just slide the knob to get any desired amount of compression. This ability to "squeeze" the dynamic range of a program with a single control is the reason the Model 163 has become known as "THE ONE-KNOB SQUEEZER." (While the 163 is factory-set for nominal -10 dB line levels, the rear-panel controls enable the user to select any convenient nominal level from -20 to +10 dB, with 0 dB = 0.775 V rms.)

The 163 features proprietary dbx true-rms detection. Most compressor/limiters use some form of peak detection, with fast-response characteristics that can have a disturbing effect on program material. True-rms-level detection closely simulates the response of the human ear. Even at 15 to 20 dB of compression, the gain-changing action of the Model 163 is highly listenable and natural-sounding.

Because of its feedforward topology, the dbx 163 compressor/limiter can achieve effectively infinite compression with complete stability and low distortion. The dbx approach is quite unlike gain reduction in a conventional compressor/limiter. Traditional gain reduction is accomplished by sensing signal level at the device's output and applying a correction signal via a feedback loop. At progressively higher compression ratios, the feedback loop's gain reduction increases, distortion increases, and eventually instability or oscillation occurs. To avoid this problem, many conventional units restrict the maximum amount of feedback, thus restricting the maximum compression to some lower ratio, such as 10:1 or 20:1. Free of the instability of excessive loop gain, the dbx 163 therefore can provide effectively infinite compression.

In addition to increasing both the stability and the available range of compression, dbx's feedforward circuitry and rms-level detector combine to make it possible for the attack time to "track" the rise of the signal envelope. In conventional compressor/limiters, the attack time depends on feedback-loop gain, which means it must be continually readjusted for best results at different compression ratios. The operation of the 163 is greatly simplified because the attack time is controlled solely by the rms detector and varies automatically with the amount of level change in the program material (the shape of the envelope).

No manual attack-time adjustments are required. The release rate — not time — is fixed by the detector characteristics at a smooth-sounding 120 dB/second. These unique circuit characteristics preserve the natural quality of any given sound.

The 163's most significant advance in preserving natural sound quality is provided by a continuously variable compression ratio which increases gradually from 1:1 toward infinity as the input level rises above the compression threshold. With a conventional hard-knee compression curve, one typically hears normal program dynamics until the input level rises above threshold; then the gain is suddenly reduced by a fixed ratio and, depending on the nature of the program, the listener senses a "holding back." With the Model 163's Over Easy characteristics, the ratio of gain reduction increases gradually as the input rises farther above threshold. Thus there is no sudden change and no feeling of holding back, just a natural-sounding program that avoids undesirably high output levels.

More on Features & Performance

The Model 163 has a 12-LED display that indicates the instantaneous amount of gain change from 2 dB to 30 dB. Input and output connections are made via unbalanced RCA phono jacks. Maximum rated input level is +17 dB (5.5 V), although the unit will accept inputs of up to +24 dB (12.3 V) without hard clipping (a moderate rise in distortion occurs as the input is overdriven). Maximum output level is +18 dB (6.2 V) into 2k-ohm or higher impedance loads.

The standard Model 163 comes with walnut sides, aluminum front and back panels, and vinyl-clad steel top and bottom panels. The unit is extremely compact, measuring just 9" wide, 1-7/8" high, and 6-7/16" deep and weighing 2½ pounds.

APPLICATIONS

dbx noise-reduction systems now make it possible to process programs with 100 dB or greater dynamic range. In some applications, however, it is necessary to curtail dynamic range. While dbx noise-reduction systems are used in the studio and in record production to maintain wide dynamic range, this range often must be restricted to optimize the sound for broadcast and home playback. The restriction of dynamic range is usually done with a compressor in the final stages of recording or record mastering. In the broadcast field, where many radio stations compete for an audience, it is felt that a high average audio level can make a big difference to ratings. Compression is used to attain high average levels. However, unless a high-quality compressor/limiter is used, distortion and unwanted audible side effects may degrade the sound so badly that the advantages of high average level are overcome and audience share is lost. The model 163 does an excellent job of reducing dynamic range in both recording and broadcast applications.

The dynamic range of a live musical performance can be even greater than 100 dB. A high-quality compressor/limiter, used judiciously, can restrict the dynamic range, raise the average level, help the operator avoid thermal damage to speakers, and improve the sound quality overall. Because the 163 sounds so natural, it won't displease performers, and thus is especially suited to sound-reinforcement applications. Compressor/limiters have been used for years to provide special "studio" effects with drums and bass guitar as well as to control "wandering" vocal levels. The 163 serves as an ideal multi-purpose performer in the small studio. See page 13 for more application ideas.

Mono or Stereo?

The 163 uses precision or matched components in critical circuits, where they make a difference to performance. In non-critical circuits, normal-tolerance components that yield excellent audio quality are used. If one intended to make a compressor/limiter for stereo operation without image shifts, one would have to use closely matched or high-tolerance components throughout, which would greatly increase the cost of the unit without providing any added benefits for mono operation.

For those applications where stereo operation is necessary and the performance of the 163 is desired, dbx has designed the companion Model 164, as noted. It is a true stereo-tracking version of the 163, featuring matched rms detectors in each channel. This "dual-detector" system provides the 164 with total freedom from the errors experienced by conventional "stereo-strapped" compressor/limiters when faced with phase error between left and right channels.

Other dbx Compressor/Limiters

dbx also offers the Model 160X single-channel compressor/limiter, with an actively balanced input and unbalanced output for use in systems requiring higher signal levels and output-drive capability, as well as the top-of-the-line 165A. The 165A lets the user control attack and release parameters, and has a separate PeakStop peak clipper to stop transients absolutely at a user-determined level. These units also feature dbx's rms-detection and feedforward circuitry and Over Easy characteristics.

The Compressor as Tool

Properly set up, a compressor is a useful device. On the facing page are a number of comparison curves for Over Easy and conventional compression settings, giving input vs. output levels (gain-change characteristics). Note what happens as one approaches infinite compression — the output is gently but absolutely limited. Above the block diagram at the lower right are compression curves for the dbx model 160X, including its negative-compression characteristic.

With a 2:1 compression ratio, a 2 dB increase in input level (above threshold) causes the output to rise only 1 dB. With a 4:1 ratio, a 4 dB increase at the input results in a 1 dB increase at the output. With a 10:1 ratio, a 10 dB increase at the input results in a 1 dB increase at the output; and so forth. Therefore, the amount of musical alteration depends on the compression ratio used as well as the threshold setting. Because the Model 163 gradually increases its compression ratio as the signal level increases above threshold, musical alteration is inoffensive, even when the threshold is low and the maximum amount of compression quite high.

A compressor/limiter, like any tool, can be misused. In fact, many people refuse to use compression even when it would improve the audio quality because they have heard compression being misused all too often. One of the nicer aspects of the dbx 163 is that it's easy to use and difficult to abuse.

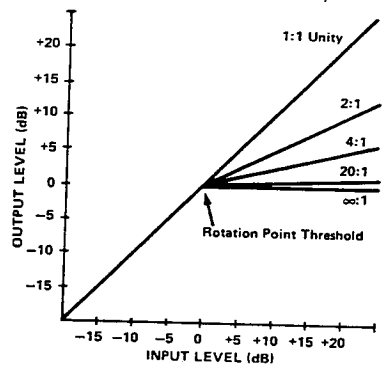
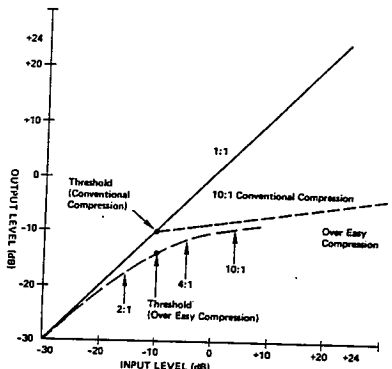

Conventional Compressor/Limiter

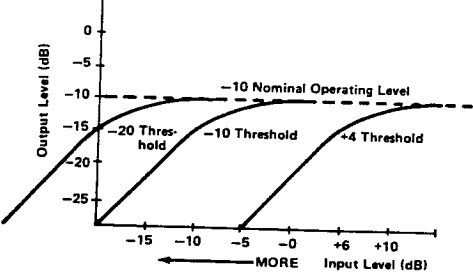

"Over Easy" Compressor/Limiter

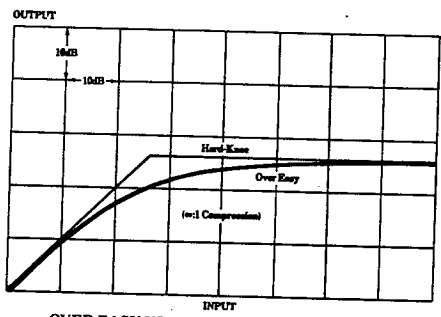

OVER EASY VS. HARD-KNEE COMPRESSION

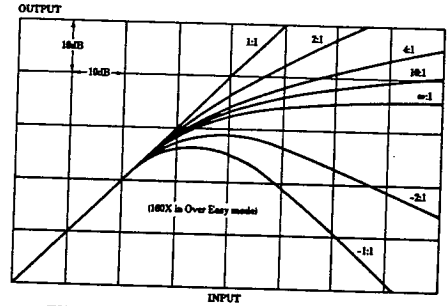

TYPICAL OVER EASY COMPRESSION CURVES

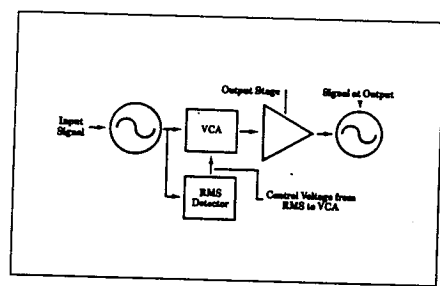

OVER EASY COMPRESSION

BRIEF OPERATING INSTRUCTIONS (see facing page)

LED DISPLAY. These 12 light-emitting diodes display the amount of instantaneous gain range (dB of compression). The first 6 LEDs are calibrated to display 2 dB steps from -2 dB to -12 dB of gain change. The other 6 LEDs are calibrated to display 3 dB steps from -15 dB to -30 dB gain change. The more gain change, the more LEDs turn ON. Note that while the display has a maximum range of 30 dB, much more gain reduction is available.

COMPRESSION. This control varies the threshold of compression from +4 dB (1.23 V rms) to -36 dB (12 mV rms) when moved from left to right (toward "MORE"). As the threshold is lowered, the overall gain of the system is increased, to maintain a constant nominal output level. The compression characteristic is the same at any threshold setting, gradually increasing from 1:1 to effectively infinite (126:1) compression as the input level increases above the threshold. The dynamics of signals below threshold remain unaltered. Refer to page 6 ff. for the Over Easy compression characteristic. (The unit can be considered to be limiting when the signal level is high enough above threshold to incur compression ratios of 10:1 or higher.)

NOMINAL OPERATING LEVEL. This recessed, screwdriver-adjustable control and adjacent switch set the nominal operating level of the Model 163. Two fixed levels may be switch-selected, -10 dB and +4 dB. In addition, the switch may be set at "variable" and the adjacent control then provides a level-adjustment range of from -20 to +10 dB. Most professional installations will require a +4 dB setting; semi-pro or hi-fi equipment may operate better at settings of -10 to -20 dB. To calibrate this setting for the system in which the 163 is being used,

run a signal through the 163 at standard operating level and slide the 163's COMPRESSION control back and forth between 1/4 and 3/4 of maximum while monitoring the output over speakers or headphones. The NOMINAL OPERATING LEVEL setting is correct when no apparent change in the output level takes place as the COMPRESSION knob is moved back and forth.

INSTALLATION

The standard package has side panels of oiled solid walnut. Adhesive rubber feet are included and may be attached if desired.

Packaging is available so that one or two Model 163s may be rack-mounted in a single 1-3/4" panel space. Under these options, dbx models RM-18-1 (for a single unit) and RM-18-2 (for two units), the wood panels are removed and brackets are provided for installation in a standard 19" equipment rack.

In any placement of the Model 163, standing alone or rack-mounted, avoid placing the unit above any heat source or strong electromagnetic fields, such as those generated by power amplifiers or vacuum-tube equipment.

AC POWER. In the US, connect the Model 163 to a 117 V ac, 50 or 60 Hz power source only. For elsewhere, the correct information is printed on the rear panel next to the power cable's entry hole. The unit may be damaged if it's not connected to the proper power source. If your unit has a switch for two different power sources, be sure it is set correctly.

SIGNAL CONNECTIONS. The 163's inputs and outputs are unbalanced, and terminate in RCA phono (pin) jacks. Make the signal connections as shown in the illustrations on the opposite page, depending on your circuit's characteristics.

(To use a 164 for mono operation, employ a Y-plug to divide the signal and send it to both 164 inputs, then connect either of the 164's outputs to your terminating unit. We suggest that you connect the signal to both inputs so that the level-detecting circuitry, which expects information in both channels, isn't fooled into inaccurate calibration by its absence in one. Note that you must never connect two different mono program sources to the 164's two channels; doing so will cause the circuitry to read both signals as one stereo program and create unwanted interactions of compression in the two programs.)

INPUT IMPEDANCE & TERMINATIONS. There is sometimes a misunderstanding about the nature of matching and bridging inputs, the use of terminating resistors, and the relationship between actual input impedance and nominal source impedance. Most electronic outputs work well when "terminated" by an input (connected to an input) having the same or higher actual impedance. Outputs are usually overloaded when terminated by an impedance that is lower than the source impedance. When the input impedance is nearly the same impedance as the source, it is known as a "matching" input. When an input is 10 times the source impedance or more, the input is considered to be a "bridging" input.

The dbx Model 163 has an actual input impedance of 25,000 ohms (a "high-Z" input, "Z" being the symbol for impedance). This makes the dbx input suitable for use with virtually any nominal source impedance, low or high. The dbx input will bridge 150-ohm or 600-ohm (low-Z) lines and will match 10,000-ohm or greater

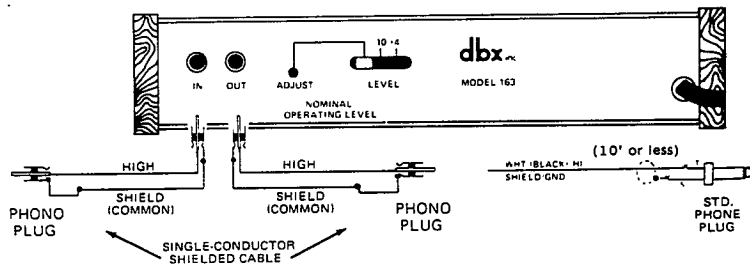

Connecting the 163 in an Unbalanced Circuit

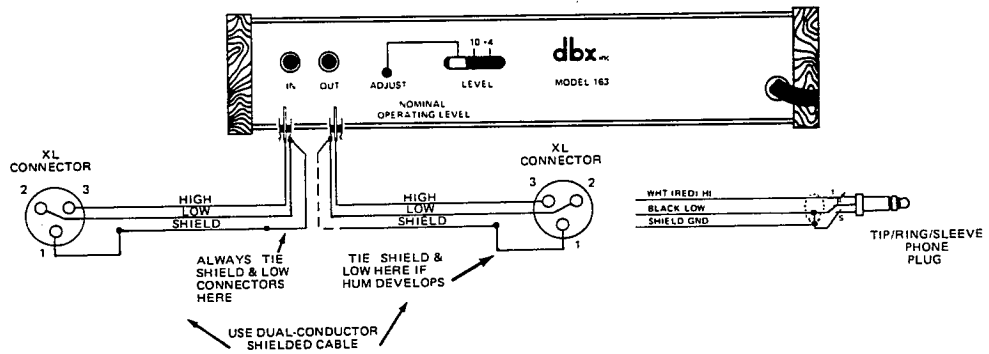

Connecting the 163 in a Balanced Circuit

impedance (high-Z) lines. Terminating resistors are not needed for the dbx unit to operate correctly; however, they may be called for to satisfy the output requirements of the preceding output. Consult that unit's instruction manual.

OUTPUT IMPEDANCE & TERMINATION. The 163's output jacks will properly feed inputs of any device whose input impedance is 2 k-ohms or greater. Note that connection to true 600-ohm lines will cause loss of bass response in the 163. Some devices labeled as having 600-ohm operation can be used with the 163 if their actual input impedance is at least 2 k-ohms. The 163 outputs will properly feed the high-Z inputs of mixers, preamps, power amps, and/or tape recorders, but if you are in doubt about the true load impedance, consult the specifications (or the manufacturer) of the unit you are feeding.

OPERATION

COMPRESSION ADJUSTMENT. Set COMPRESSION at minimum (slider all the way left). Apply average-level program material to the input. The LED display should be off. (With sufficiently high input levels, the LED display will light up regardless of the COMPRESSION slider's position.) Increase the COMPRESSION by moving the knob to the right (toward MORE) until the first one or two LEDs begin to flicker on program peaks. At this setting, no more than a few dB of compression are obtained, and the ratio remains low. Further advancement of the COMPRESSION control toward the right does two things: (1) it starts compression at a lower point relative to the maximum input level, and (2) it applies more compression to the higher-level portions of the input. The instantaneous compression (in dB) is indicated by the LED display; more LEDs ON means that more of the program is being compressed. It is suggested that

the unit be set for only as much compression as required.

NOMINAL-OPERATING-LEVEL ADJUSTMENT. The Model 163 comes set for unity gain at the nominal operating level of -10 dB, meaning a -10 dB input will appear as a -10 dB output when the COMPRESSION control is pushed past the 1/4 point. As the COMPRESSION is increased, the gain of the system is increased by a corresponding amount, decibel for decibel, so that the average output level remains the same — -10 dB. If it is desirable to change the nominal output level, this can be done with the rear-panel NOMINAL OPERATING LEVEL switch and control.

The Model 163's Over Easy compression is very forgiving of peak overshoots, and audible distortion is difficult to create with the unit. However, audio signals often have peaks that are 20 dB above VU-meter readings (VU meters indicate average levels). Even when compressed at a 2:1 ratio, such peaks can still reach 10 dB above VU-indicated levels. To avoid distortion in the most critical applications, use an average input level that is well below the peak +24 dB input level (i.e., average between -20 and +8 dB).

LED-DISPLAY INTERPRETATION. If the LEDs are not illuminated, the input program is below the threshold of compression, so little or no dynamic alteration is occurring. As the input program level approaches the compression threshold, one or more LEDs will turn ON: the higher above threshold, the more compression and the more LEDs turn ON. The actual amount of compression can be read out directly, as labeled above the LEDs. (The first 6 LEDs each represent 2 dB of compression, and the next 6 represent 3 dB each.) When the entire LED display is ON, the unit is generating 30 dB or more of compression.

COMPRESSOR/LIMITERS: A REVIEW

COMPRESSOR: A variable-gain amplifier whose gain decreases as the signal at its input increases through a set threshold.

LIMITER: A compressor with a high compression ratio; the high ratio maintains essentially constant output level despite any increase in input level above the threshold.

OVER EASY COMPRESSOR/LIMITER: A compressor in which the compression ratio increases as the input signal rises through the set threshold. Thus, for signals near the threshold, the unit functions as a low-ratio compressor, gently reducing the amplifier gain. For signals well above threshold, the unit functions as a limiter, substantially reducing gain and preventing the output level from rising regardless of further increases in input level. Because the Over Easy compression "comes on" gradually, limiting is far less audible than with conventional compressor/limiters.

COMPRESSION RATIO: The ratio, in dB, of input-level changes (above threshold) to output-level change. A compressor whose output level changes 1 dB for a 2 dB input-level change has a 2:1 compression ratio.

THRESHOLD: The level at which compression begins. In dbx's Over Easy compressors, we define the threshold as the level at which the compressor generates 6 dB of gain reduction. The dbx Model 163 compressor/limiter has an adjustable threshold (set by the COMPRESSION control). If the input level is above the set threshold, the unit functions as a compressor or as a limiter, depending on how far above threshold the input-signal level rises.

MORE APPLICATIONS

CHANNEL PATCHED. By placing the 163 in the "pre-fader loop" or between the "patch points" of a channel in an audio console, a specific instrument or vocal can be processed.

Vocals. When a singer or speaker has a tendency to move closer to and farther away from the microphone, the 163 can smooth out the level variations which would otherwise occur. Large amounts of compression on a lead vocal will cause it to cut through the mix and give it a greater feeling of intimacy due to the increased gain provided for subtle vocal inflections.

Instruments. The 163 can be used to even out an instrumental level. For example, an electric bass will frequently have dead spots, which produce softer notes than those in other places on the finger board. The 163 will smooth out the level variations due to either the nature of the bass or the action of the musician.

In general, larger amounts of compression produce a fatter sound. This is typically used to increase punch or kick drums or to alter the "wash" of a cymbal for increased impact.

MIX PATCHED. By placing a 163 in the submaster or "group" points of an audio console, entire groups of instruments or vocals can be processed. This provides the mixer with greater control over the level, for example, of a horn section relative to other parts of the mix. This is important because there

will generally be another compressor/limiter on the entire output of the console, and without control over each submix, the horns (in this example) could get loud enough to dominate the mix and effectively force the rest of the channels down in level.

This is an important concept — that whenever several signals are run through a single limiter which is setting the maximum system output, an increase in the level of any signal will cause an apparent decrease in the level of other signals (so that the same total level is maintained). It follows, therefore, that the most accurate control of the mix is achieved by compressing at the earliest possible stage in the signal chain. That is, the most control is obtained at the channel-patch point, somewhat less at a submix or group match point, and there is no control of the relative levels within the mix when the compressor is at the output of the console. Since a limiter is almost always placed at the console output to control the level of the total mix, it is common to find compressor/limiters at all three positions in the signal chain.

For mono applications of a stereo audio console without submix or group busses, one of the two stereo outputs can be used as a submix. In the example above, all of the horns could be panned totally into the left output and everything else into the right output. The left-output fader would then act as the horn submix. It could be patched through a 163 and the compressed signal returned to the console's right channel via the Aux return. The right-output fader would now act as the master mono-output fader.

OUTPUT PATCHED. When placed at the output of an audio console, the 163 can provide several benefits for both sound reinforcement and recording.

A) Sound Reinforcement. By using the 163, greater control over the rms level in the house and/or monitor systems is obtained. This will provide greater intelligibility, higher apparent levels, and greater protection from speaker destruction. The limiter 163 should be the last processor in the signal chain before the power amplifier. As a general rule, it should be set up as follows:

- 1) With the power amps turned to a low setting, follow the Nominal Operating Level setup.
- 2) With signal running through the console at nominal levels, adjust the 163 for approximately 12 - 18 dB of compressor display.
- 3) Turn the power amps up until their clip lights begin to flicker, then back them off until the lights go out.

NOTE: Obviously, this presupposes a sound reinforcement system that has been properly designed. Do not, on the basis of this set-up procedure, knowingly exceed the power rating of the system's expander. dbx warranties cannot be extended to cover the failure of other components in the signal chain.

B) Recording. By recording the full mix through a compressor prior to recording, greater average level can be obtained with less distortion. This is important when the recording is being made without the benefit of dbx noise reduction, because the dynamic range of the tape is generally insufficient to accommodate the music being recorded. For stereo mixes, a stereo limiter such as the dbx 164 should be used in order to maintain a stable stereo image during compressed passages.

SPECIALIZED APPLICATIONS

A) Religious Services. The 163 is of great value for processing the pulpit mike. Its Over Easy compression allows softspoken lay readers to be heard while increasing the sense of intimacy achieved by a trained orator without giving a feeling of "holding back" the power of a sermon. It is also ideal for processing audio which is being fed to a cassette master recorder, hard-of-hearing systems, remote-listening rooms, or a radio program.

B) Industrial Audio. The 163 allows paging and background music systems to accept a variety of inputs from various microphones and music sources while maintaining a constant sound-pressure level throughout the facility. In the case of stereo systems, such as remote bar speakers in a discotheque, a 164 should be used to maintain the stereo signal at the correct level.

The 163 may also be used for teleconference systems, where it improves intelligibility and maintains constant transmission levels.

SPECIFICATIONS

Input impedance	25 k-ohms, unbalanced
Input level	+17 dBm nominal maximum, +24 dBm clipping point
Output impedance	less than 47 ohms (active low-Z output)
Output level	+18 dBm into 2 k-ohms
Threshold range	-36 to +4 dBm (12 mV to 1.2 V rms), variable
Compression ratio	Automatically varies, from 1:1 below threshold to ∞ :1 above threshold, in accordance with Over Easy curve
Maximum compression	Greater than 50 dB
Attack time (measured in the infinite-compression region of the threshold curve as the time required to reduce the signal by 63% of level increase, above threshold)	Program-dependent: 15 ms for 10 dB increase in input level (above threshold), 5 ms for 20 dB, 3 ms for 30 dB
Release time	Program-dependent: varies automatically from 0-420 ms, affected by settings of front-panel control
Output gain	Variable from 0 to +40 dB, depending on front and rear controls
Slew rate	greater than 10 V/ μ s
Dynamic range (the difference between the maximum signal level and the A-weighted noise floor as measured at the output)	greater than 106 dB
Equivalent input noise (unweighted)	less than -89 dBm, 30 Hz-20 kHz
Frequency response	5 k-ohm load:+0,-1 dB, 30 Hz-20 kHz; 2 k-ohm load:+0,-3 dB, 30 Hz-20 kHz

Distortion below threshold (at 1 kHz, 0 dBm input and output)	2nd harmonic 0.1%, 3rd harmonic 0.1%
Distortion above threshold (measured at -10 dBm nominal level setting; figures typical at infinite compression, 1 kHz, 0 dBm input and output; 2nd harmonic is relatively unaffected by compression ratio, time constants, and frequency, while 3rd harmonic decreases with slower time constants, higher frequencies, and lower compression ratios).	2nd harmonic 0.1%, 3rd harmonic 0.2%
Metering	Single (163) or dual (164) 12-LED display from -2 to -30 dB
Dimensions	163: 1 7/8" h x 9" w x 6 7/16" d; 164: 1 3/4" h x 19" w x 6 3/8" d
Weight	163: 2.5 lbs. 164: 5.2 lbs.
Power requirements	see rear of unit (USA & Canada: 117 V ac + 10%, 50-60 Hz, 6 or 12 watts, depending on which unit)
Accessories	For 163 only: RM-18-1 rack-mount kit for one, RM-18-2 kit for two

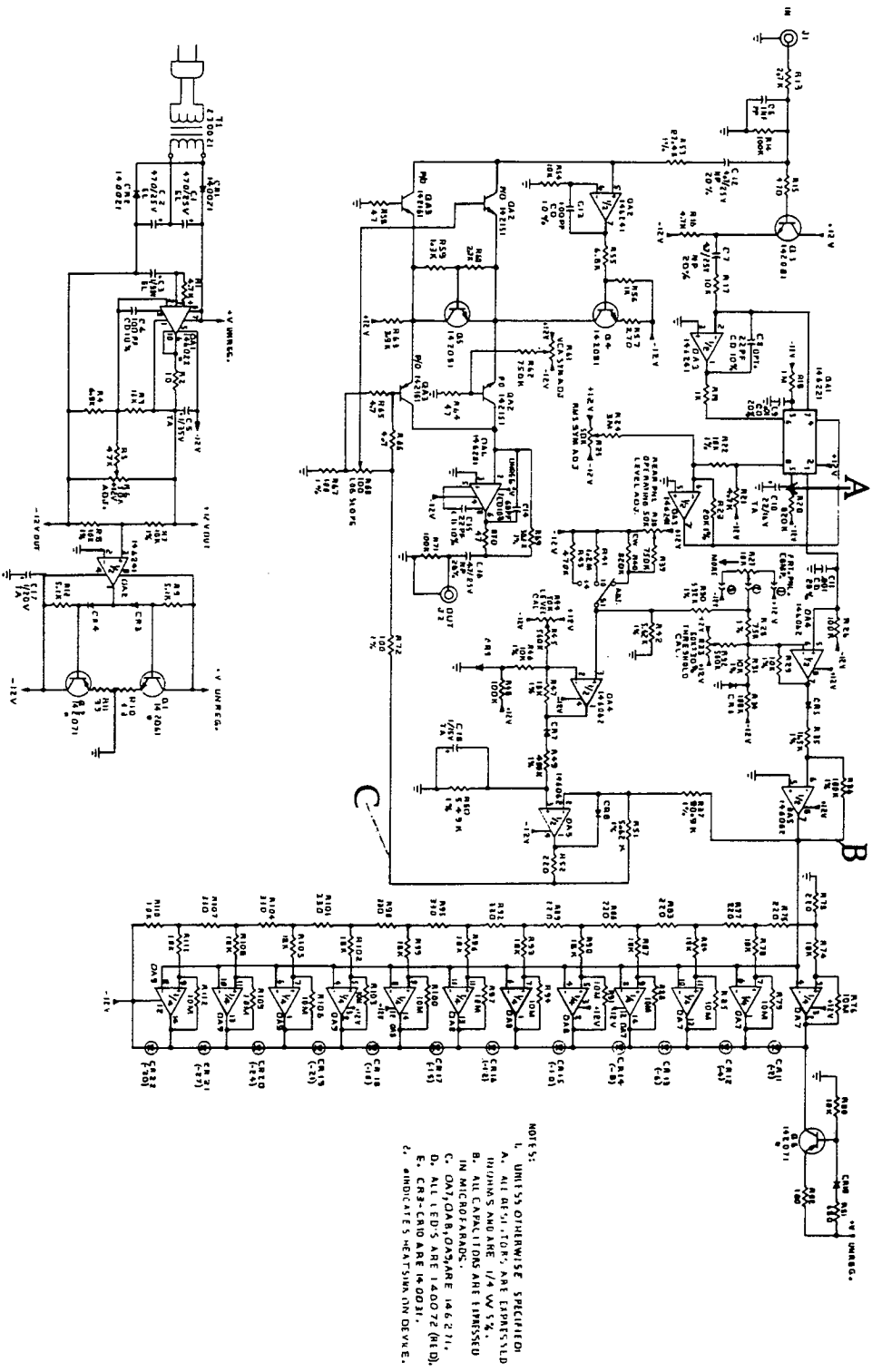

Model 163 schematic (see following page for appropriate connections)

WARRANTY and FACTORY SERVICE

All dbx products are covered by a limited warranty (warranties for products purchased outside the USA are valid only in the country of purchase and the USA). For details, consult your warranty/registration card or your dealer/distributor.

The dbx Customer Service Dept. will help you use your new product. For answers to questions and information beyond what's in this manual, write to:

dbx Inc.
71 Chapel St.
Newton, Mass. 02195 USA
Attn: Customer Service

You also may call (617) 964-3210 during business hours (USA Eastern time). The Telex is 92-2522.

Should problems arise, consult your dealer or distributor. If it becomes necessary to have your equipment serviced at the factory, repack the unit, including a note with a description of the problem and the date of purchase, and send the unit freight prepaid to the above address, marking it Attn: Repairs.

FOR USERS IN THE UNITED KINGDOM

Important

The wires in this mains lead are coloured in accordance with the following code:

Blue: Neutral
Brown: Live

As the colours of the wires in the mains lead of this apparatus may not correspond with the coloured markings identifying the terminals in your plug, proceed as follows:

The wire that is coloured blue must be connected to the terminal that is marked with the letter N or coloured black;
The wire that is coloured brown must be connected to the terminal that is marked with the letter L or coloured red.

Ensure that all terminals are securely tightened and that there are no loose strands of wire.

Warning

This unit must be protected by a 3-amp fuse, preferably using a fused plug.

Also, do not remove the cover without first disconnecting the unit from the mains supply.